

CINEGON 1.4/8.0MM

$$\begin{aligned}
 f' &= 8.3 \text{ mm} & \beta_p &= 4.643 \\
 s_F &= 11.7 \text{ mm} & s_{EP} &= 13.5 \text{ mm} \\
 s_{F'} &= 12.6 \text{ mm} & s_{AP} &= -25.8 \text{ mm} \\
 HH' &= 21.2 \text{ mm} & \Sigma d &= 36.8 \text{ mm}
 \end{aligned}$$

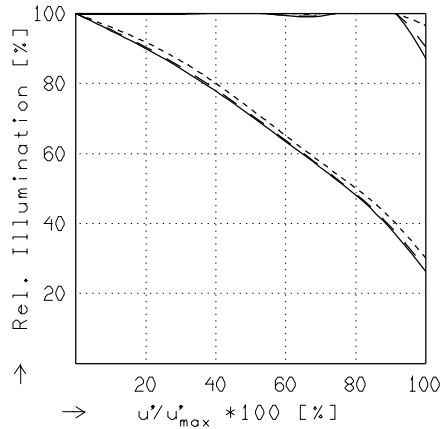
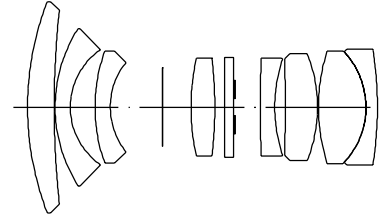

RELATIVE ILLUMINATION

The relative illumination is shown for the given focal distances or magnifications.

$$f / 1.5 \quad f / 4.0 \quad f / 8.0$$

—	$\beta' = 0.0000$	$u'_{max} = 5.5$	$00' = \infty$
- -	$\beta' = -0.0200$	$u'_{max} = 5.5$	$00' = 451.$
- · -	$\beta' = -0.1000$	$u'_{max} = 5.5$	$00' = 121.$

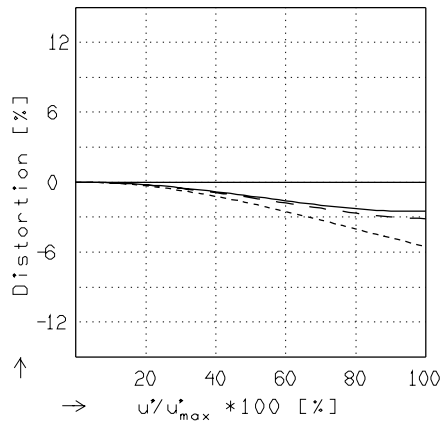

DISTORTION

Distortion is shown for the given focal distances or magnifications. Positive values indicate pincushion distortion and negative values barrel distortion.

—	$\beta' = 0.0000$	$u'_{max} = 5.5$	$00' = \infty$
- -	$\beta' = -0.0200$	$u'_{max} = 5.5$	$00' = 451.$
- · -	$\beta' = -0.1000$	$u'_{max} = 5.5$	$00' = 121.$

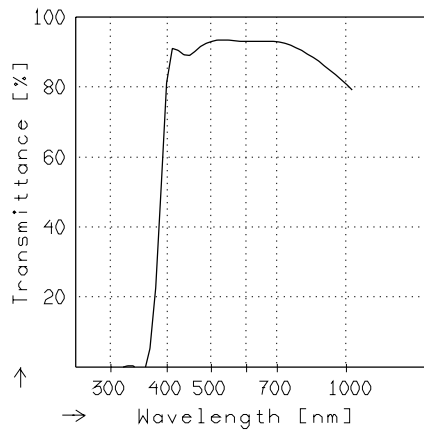

TRANSMITTANCE

Relative spectral transmittance is shown with reference to wavelength.

CINEGON 1.4/8.0MM

MODULATION with reference to the relative image height

Wavelength λ	[nm]	587	940	820	707	480	405
Spectral weighting	[%]	28.8	12.2	14.9	23.6	12.8	7.7
Spatial frequency R	[1/mm]	10	20	30			
Format	[mm X mm]	6.6	X	8.8			
Diagonal $2u'$	[mm]	11.0					

radial —
tangential - -

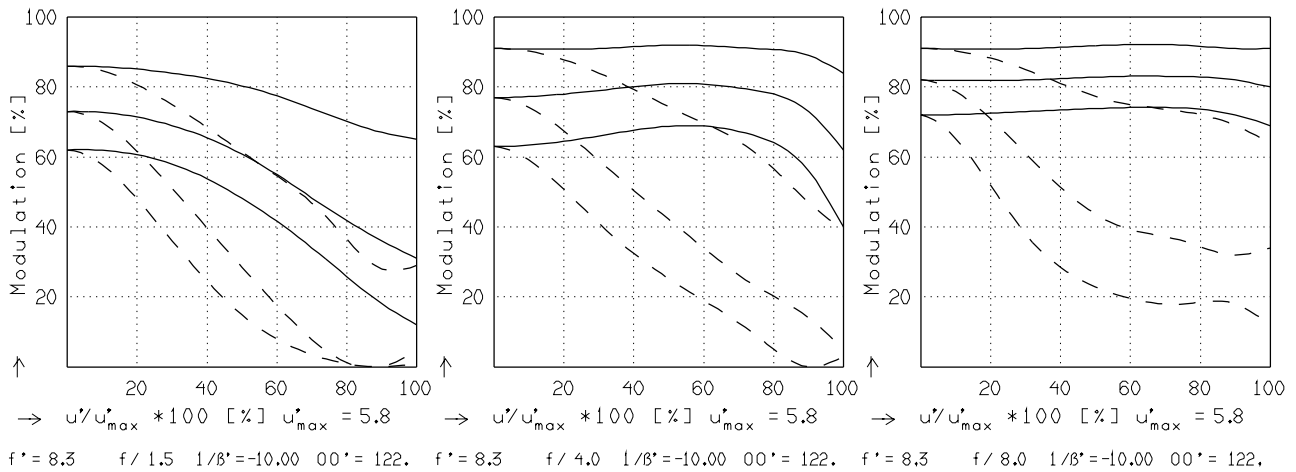
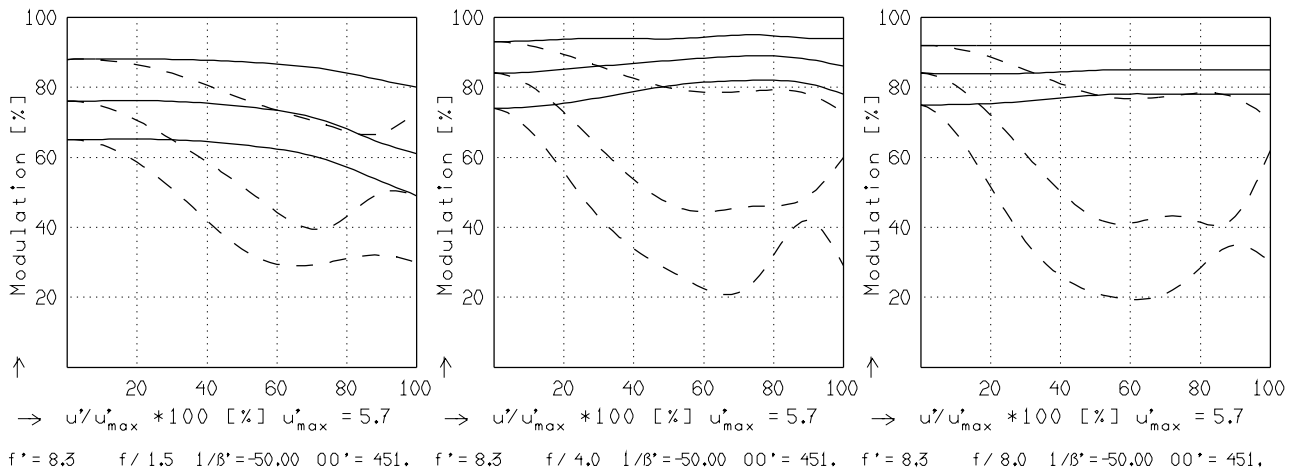
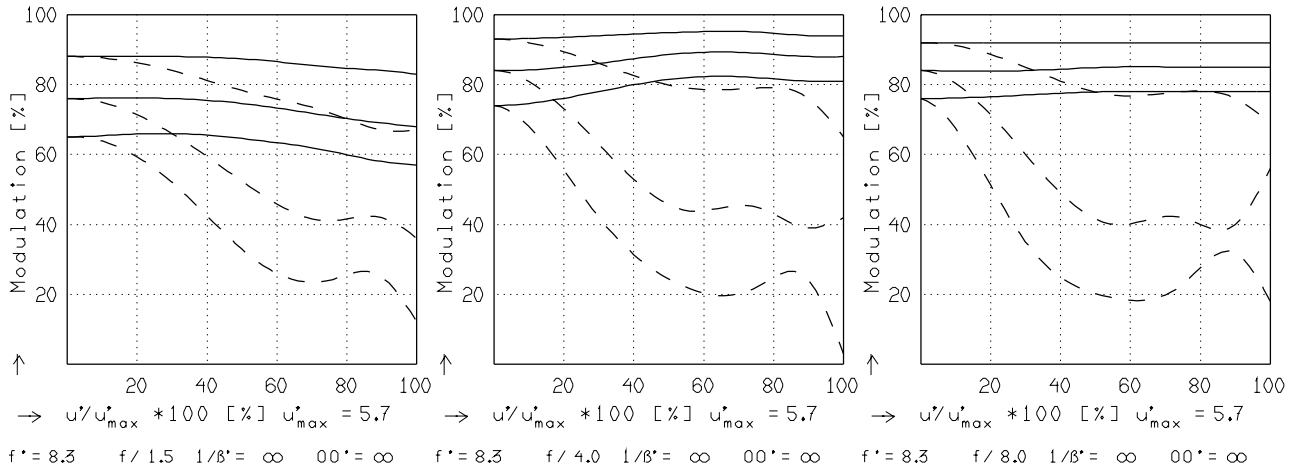

Focusing : MTF_{max} at $f / 1.4$, $R = 30$ 1/mm, $u'/u'_{max} = 0$

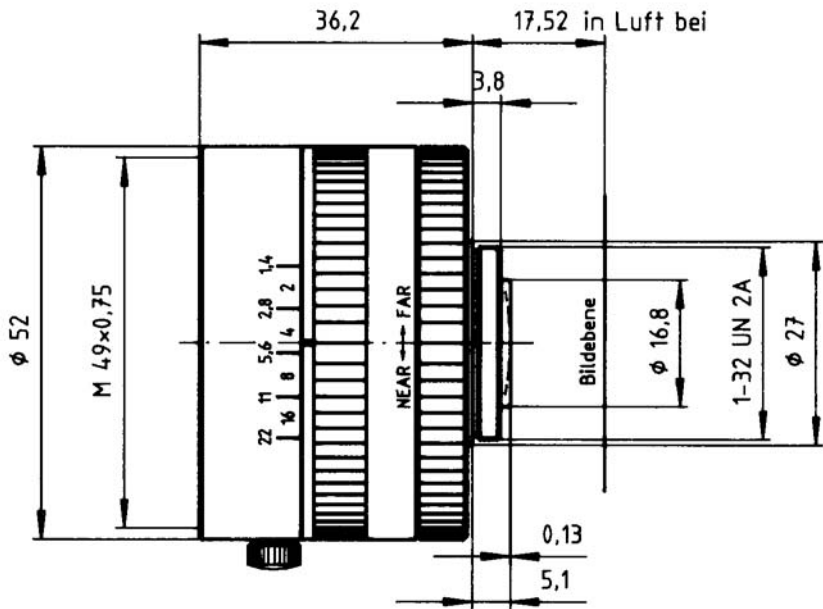

Cinegon 1,4/8 in man. Blendenkörper